

UNICARRIERS[®]

□ FORKLIFT □

BX Series



Electric Counterbalanced Forklifts

36 & 48 Volt AC-Powered
3,000 - 8,000 lb Capacities | Cushion Tire



BX Series Applications

Greater performance, higher capacity and advanced features make the BX Series *the* choice for demanding applications, including:

- Manufacturing • Warehousing
- Distribution • Bottling



Look for these symbols for features available only on UniCarriers forklifts or that provide a proven performance advantage as compared to competitive trucks.



NEVER QUIT.

It defines our forklifts and the company that builds them.

Over the course of a century, the company known as UniCarriers took shape. As we grew and evolved into a US manufacturer with a global reach in nearly 100 countries worldwide, much has changed, but one thing hasn't: our mission. UniCarriers is committed to providing you with the ultimate in reliability, performance, and value.

And that commitment can be seen in the BX Series, a versatile lift truck that combines a capacity of up to 8,000 lb and exceptional power efficiency with an advanced feature package that includes self-contained onboard diagnostics and controlled rollback. Plus, it's backed by the best standard, unlimited warranty in the business. Add UniCarriers legendary reliability, ease-of-maintenance and preset performance modes — and you have the right forklift to move your products, and your business, forward.



Up Your UpTime

Discover reliability features that cut downtime and keep your business up and running



Comfort Zone

Your drivers and your entire operation will benefit from our comfort & productivity features



Power & Performance

100% AC motors and controllers are only the beginning of our performance advantages



Sweet Savings

The BX is designed to deliver you a low cost of ownership year after year after year



Play It Safe

Safety is everybody's business, and the BX is all business when it comes to safety



Control Freak

With the BX, you're in complete control when it comes to managing costs and productivity



Make It Yours

Already well appointed, the BX can be customized to meet your specific needs



To learn more, and a find a dealer near you, visit UniCarriersAmericas.com



Up Your UpTime



Reliable AC Technology

The BX Series is powered by our 100% AC motor and hydraulics systems. With **better cooling capacity and greater reliability** even in humid environments, AC power delivers more consistent and higher performance throughout the shift on a single battery charge for more uptime and greater productivity.



Stay Cool

Built-in thermal sensors help protect the motor and controller systems, promoting more **reliable performance**. A warning will flash on the LCD screen to advise the operator if overheating has occurred, followed by reduced travel and lift operations. Information is automatically locked into the truck's service history to assist the technician and speed servicing.

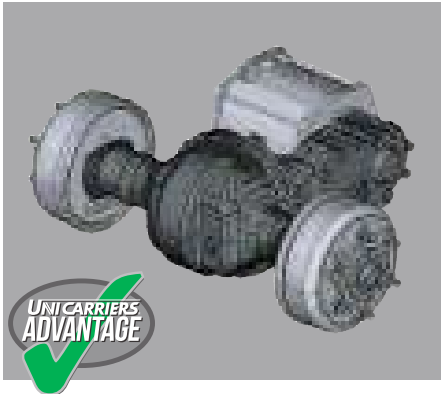

Dependable Drive Unit

Our brushless AC induction drive motor has **fewer parts to maintain** and is perfectly matched to a simple, yet highly efficient, transmission. The result? Greater dependability and higher performance.

Reduce Downtime through Self-Diagnostics

Integrated on-board diagnostics provide immediate truck status. Its intuitive dialogue display combined with accessible service history reduce troubleshooting time, so the unit is back in operation faster. Everything is done through a smart LCD panel. No handset device is needed.



Simplified Battery Maintenance & Replacement

Gas stay assist keeps the **hood open nearly 90°** making routine battery maintenance and change-outs faster. Optional rollout design further simplifies battery removal. Larger battery box models accommodate bigger batteries and allow for longer run times between charges compared to the smaller battery box models.*

*Available on 40R and 50R models.



Comfort Zone

Work comes first, but there are amenities that make the experience more pleasurable. And happy drivers are statistically more productive.



Excellent Visibility

A standard high visibility carriage* and your choice of an OPTIVIEW®, triple stage or wide-view mast — together these features produce clear sightlines for both loading and moving.

** Available at no additional cost on model capacities up to 5000 lb*



Our Seat Supports Your Driver and Your Productivity

The lumbar support and weight adjustments create customized comfort for the operator, while a non-cinching seatbelt allows a wider range of movement. The full suspension design absorbs shocks for a smoother, more comfortable ride — and it's all standard on BX Series forklifts.

Seat and backrest cushions can be individually replaced. Cloth or vinyl available.



Lumbar support adjustment

Weight adjustment



Improved control and security

Traveling in reverse can be more comfortable with an optional secure assist grip. It helps keep the operator's hand inside the compartment where it belongs. A horn button is included.



Convenience at Your Fingertips

Standard automotive-style controls are located on either side of the steering column for accessibility and intuitive operation.

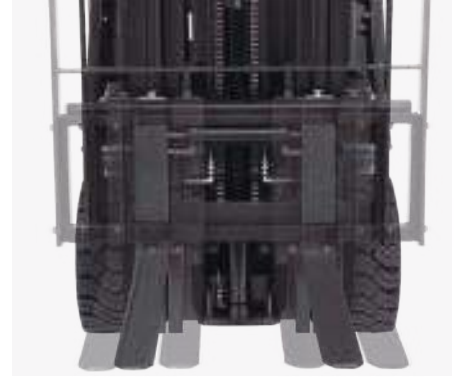

Side-shifting Fork Positioner

Optional feature hydraulically positions forks, eliminating the need for manual adjustment by the operator while providing increased productivity.



*Headroom based on 4000-8000 lb capacity models. (41.5" for 3000 & 3500 lb capacity models.)



Power & Performance

Highly Responsive, Highly Productive.

The BX Series' AC power system delivers responsive, precise control for greater productivity throughout the work cycle. Faster acceleration, higher top travel speeds and infinitely variable lift/lower control mean more work is completed, faster.

3+1 Performance Modes = Greater Productivity

The BX Series features adjustable settings to optimize performance based on the application, work environment or operator experience. Choose from the three factory-set modes (shown below) to easily customize your lift truck. The BX also has a manual mode to create unique settings, finely tuned for your operator and operation.



- E Economy Mode**
Extended operating hours achieved with only slightly reduced performance.
- P Power Mode**
Offers mid-range settings for normal performance needs.
- H High Power Mode**
Reach maximum desired performance.
- M Manual Mode**
Provides access to create customized performance parameters.





Rugged UniCarriers Designed and Manufactured Mast

Our mast features rolled steel channels and thick inner rails for increased capacity retention. Side thrust rollers on the fork carriage are easily accessed for carriage adjustment.



Fast Acceleration, Travel and Lift Speeds

Use the high performance setting to reach top speeds and optimize productivity. Program the truck's response time through its Flex-Logic system for quicker acceleration.

Travel Speeds

9.3 / 10.6
MPH

Full load / No load

Lift Speeds

68 / 119
FPM

Full load / No load

Gradeability

20.5
%

Full load

**Based on 48-volt 5000 lb capacity cushion tire model*



Sweet Savings

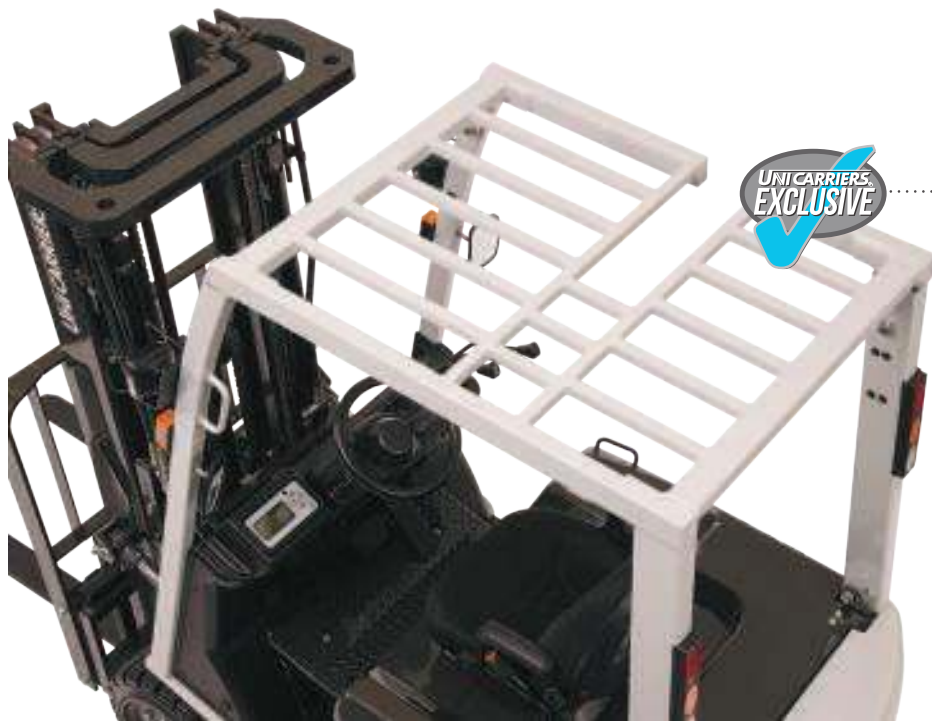

Our Overhead Guard Reduces Your Overhead

Beyond ample headroom, the five-piece overhead guard can save as much as 75% of your time when making needed replacements. That cuts downtime and costs.

Save Precious Battery Power

Industrial batteries can be a significant part of your operational expenses. The BX incorporates power saving features to optimize battery usage so you can get the most out of your investment.

Advanced regenerative technology **reclaims power** from five different operations, lowering power consumption and **reducing component wear** through less heat generation — to keep your equipment **operating longer**, with less time in the charging bay.

An auto power-off cuts the electrical system if the forklift sits idle. Select an allowable idle time between 15 and 60 minutes before the vehicle powers down.

On-demand power steering system draws battery power only when required.

- 1 Switchback regeneration
- 2 Foot brake regeneration
- 3 Accelerator-off regeneration
- 4 Controlled rollback regeneration
- 5 Lifting/lowering regeneration



Fewer Motors to Maintain

The 100% AC-powered system on the BX features brushless drive and pump motors and a single contactor. The **steering system is electronically controlled and powered through the hydraulics**, thus eliminating the need for — and added expense of — a separate steering motor.

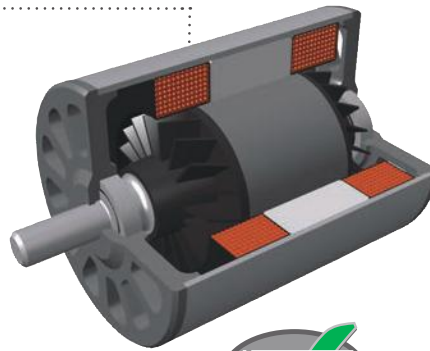

Programmed Savings

Program the forklift's settings so travel speed is reduced once the driver's foot is removed from the accelerator during operation. This standard deceleration feature **draws less energy and extends brake life.**

Minimize Preventable Repairs

Operators are more likely to perform regular lift truck inspections if they are easy to do. Access to hydraulic and brake fluids is convenient, making daily checks or required refills simple, so operators can focus on the job ahead.



Remove rear panel for access to the controller for inspection and planned maintenance.



Access to hydraulic fluid located under door on right side step, for regular inspections and refills.



Two-piece diamond tread floorboard includes door to access brake fluid for visual level inspection and refills.



Side panel located behind left entry step offers access to relays and fuses.



Play It Safe



Forward Thinking Back Up Alarm

Our back-up alarm provides plenty of notice to pedestrians and other drivers in the area. For applications with varying noise levels, there is an optional self-adjusting alarm that adjusts sound volume based on ambient noise levels.

Reverse driving actuates optional blue spotlight to illuminate the floor, for advanced visual warning.



'ES' Rating is standard on all BX models, offering extra safeguards to the electrical system. Compare against competitive models that charge extra for this. An optional 'EE' Rating is also available.

Rubber damper provides excellent stability and easy handling

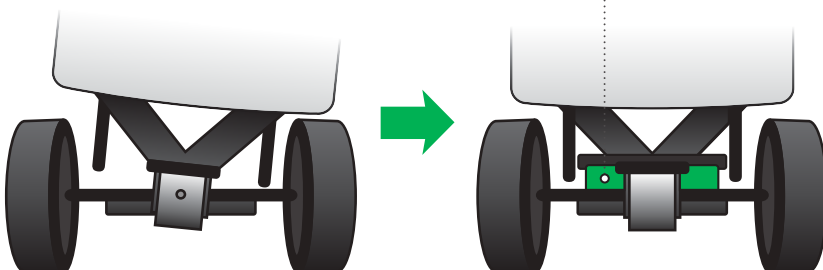

Safety Doesn't Have to be Complicated



Unlike the complex systems offered by some competitors, our cushion stability control is simple, extremely effective and **zero maintenance** – excellent lateral stability is achieved by a rubber damper placed between the axle and frame.



Operator Presence System

This comprehensive system includes a **seat-actuated power interrupt with mast-lock**, automatically preventing lift and tilt operations if the operator leaves the seat. The **return-to-neutral** feature minimizes forklift movement if the operator leaves the truck while still in gear. Other audible and visual warnings come standard, including parking **brake warning and seatbelt alarm**.



Seeing is Believing

Cylinders are positioned behind the mast rails resulting in fewer visual obstructions for the operator. Ideal for facilities that transport delicate loads, our optional OPTIVIEW® mast makes fork positioning and load handling easier.

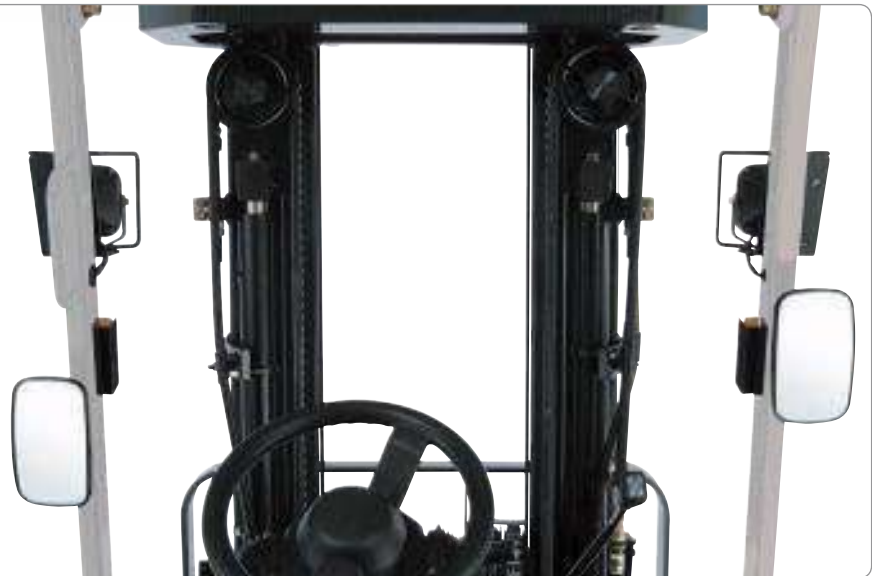

Password Protected Security

Using a PIN code/password entry feature helps assure that **only authorized drivers are operating your BX**. Up to five unique performance settings can be created, based on application and/or individual operator skill level.

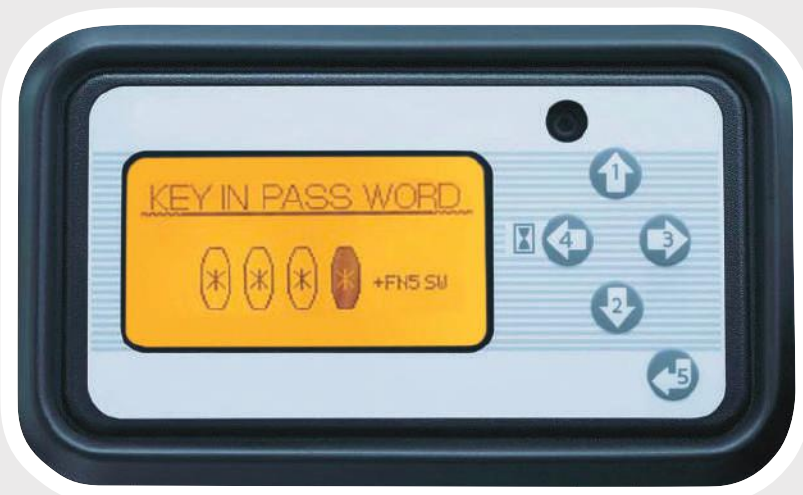



Control Freak

Maintain Control

When operating on inclines, our **Controlled Rollback** feature uses regenerative braking to automatically maintain a slow, consistent speed on a ramp incline when the accelerator pedal is released. This eliminates the need for continuous brake pedal force by the operator.



Low effort hand release



Single Handle Control Lever

Faster, easier and more fluid, our single handle control **combines both lift and tilt functions for greater productivity**. It is standard equipment on the BX Series— and not available from any other forklift brand. Separate control levers are available at no charge.

Automotive-Style Parking Brake with Warning

As part of the Operator Presence System, a warning buzzer alerts the driver if he leaves the seat without first setting the parking brake. Conveniently located, the parking brake design makes it easy for the operator to quickly depress the pedal to apply the brake. A display indicates when the brake is engaged. A simple hand release is included.

The Ultimate in Control

The interactive meter panel on the BX provides operators and technicians with a wealth of information through its LCD warnings and readouts. Using the numbered function keys, you can program settings, perform maintenance tasks, and access service history.

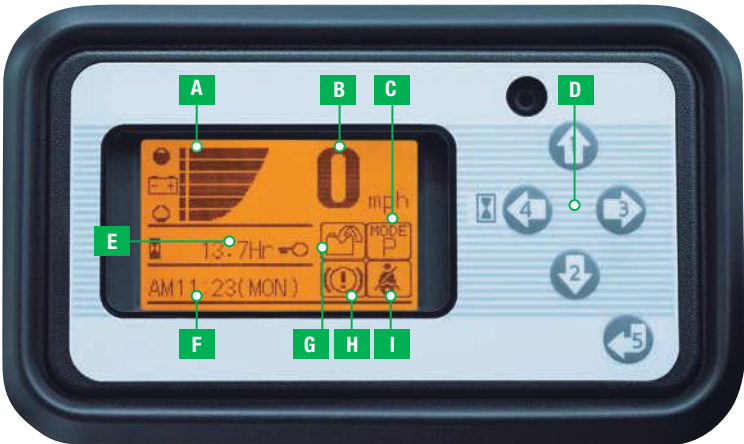

Our multi-function display provides an at-a-glance view of critical functions:

- A** Battery discharge indicator
- B** Speedometer
- C** Performance mode
- D** Function keys
- E** Hour meter reading — 4 operational modes
- F** Clock/alarm & acceleration level
- G** Regeneration indicator
- H** Parking brake warning
- I** Seat belt warning

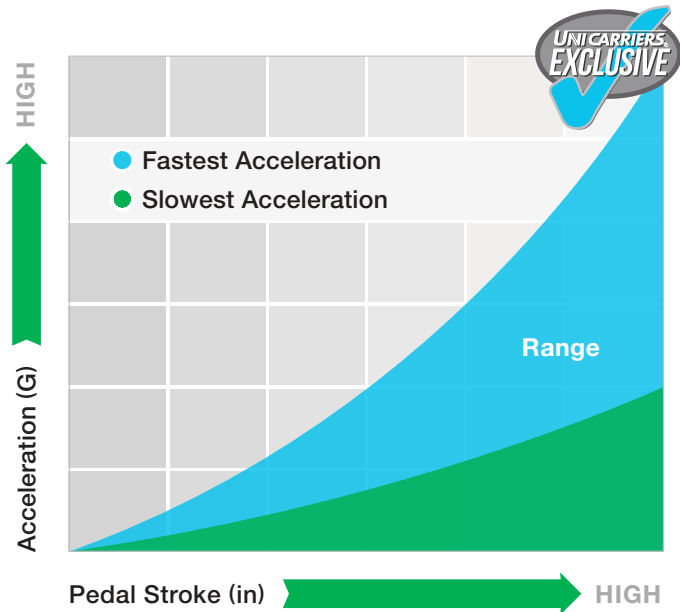

Sensitive to Your Acceleration Needs

With our exclusive Flex-Logic system, the quicker the accelerator pedal is depressed, the faster our BX Series will respond to your command for speed. This feature is ideal for fast paced operations and where long runs are common. Operators can also maintain a slower acceleration rate by reducing their pedal force when pedestrians are present or in more confined areas of the warehouse. In addition, the operator can adjust the acceleration rate through the meter panel, for even faster or slower response.





Make it Yours

Choose from a variety of options to customize your ride. If you don't see what you need, contact your authorized UniCarriers dealer for help.

- Blue LED Pedestrian Awareness Light



- Strobe Light



- Fire Extinguisher



- Clamp Release Switch





Extended Overhead Guard

Extension provides protection to mounted components, including onboard computer and headlight (shown).

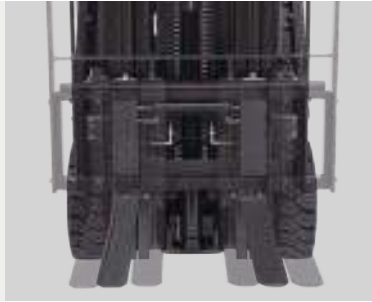

Side-shifting Fork Positioner

Hydraulic fork adjustment prevents operator strain by eliminating the need to manually move forks for different pallet types for increased productivity.



Auto-Tilt Leveling System

Press the button on the hydraulic control lever to tilt the forks forward to a horizontal position. Used for easier load placement and retrieval operations.



Reverse Assist Grip with Horn

Provides operator control while driving in reverse. Keeps operator's hand securely inside the compartment during operation.



High Visibility Seatbelt

Bright orange seatbelt provides instant visual confirmation that operators are using this safety equipment.



Hydraulic Quick Disconnect

Simplifies change-out when multiple attachments are used to get your forklift back in operation quicker.



Freezer Package

Provides protection in cold storage or freezer environments in temperatures as low as -31°F (-35°C). Package includes special hydraulic oil and steel tubing, rubber floor mat and tilt cylinder boots.



Steering Wheel Spinner Knob

Provides easier operator control and handling.



Accumulator

Ideal when handling fragile loads. Feature absorbs shocks transmitted while driving over uneven or cracked floors to make load handling and travel smoother.

Option Availability

● Standard ○ Optional

VEHICLE MANAGEMENT	
AC TECH motor controller system	●
Interactive LCD meter panel with adjustable performance settings	●
Operator security PIN access	●
3 Pre-set performance modes (Economy, Power, High Power)	●
1 Manual (custom) performance modem	●
On-board diagnostics, self-test and coded service history	●
Low battery lift interrupt system	●
Controlled rollback	●
BATTERY/ELECTRICAL	
36 Volt system	●
48 Volt system	○
Battery compartment rollers	○
BRAKE	
Foot-applied parking brake with warning buzzer	●
5-Mode regenerative braking	●
MAST	
Seat actuated auto-mast lock system	●
OPTIVIEW® three-stage mast	○
High-visibility carriage (up to 5,000 lbs capacity)	●
HYDRAULIC SYSTEM	
Single lift/tilt control lever	●
Separate lift & tilt control levers	○
Auto-fork leveling	○
Accumulator	○
Extra tilt	○
Quick disconnect	○
OPERATOR CONVENIENCES	
Full suspension seat with weight and lumbar adjustment	●
Overhead guard-mounted headlights	●
Rearview mirrors	○
Rear combination light package (turn, stop, back-up)	○
Rear work and strobe lights	○
Secure assist grip with horn button	○
Steering wheel with spinner knob	○
Magnetic convenience box	○
Full suspension cloth or vinyl swivel seat	○
Overhead-guard - Raised 2.4"	○
PROTECTION/SECURITY	
Operator Presence System with return-to-neutral & seat-actuated auto-mast lock	●
Back-up warning alarm	●
Self-adjusting back up alarm	○
Orange seat belt	○
Fire extinguisher	○

Some options may require additional lead time. Consult your local authorized UniCarriers Dealer for details.
 BX cushion tire models comply to UL583 Type ES, with optional Type EE compliance. Consult Factory for details.

Specifications

CUSHION TIRE 3000 – 8000 lb MODELS

SHORT MODEL CODES	BXC30N	BXC35N	BXC40N	BXC40R	BXC50N
Load Capacity - lbs	3000	3500	4000	5000	5000
Voltage	36 / 48	36 / 48	36 / 48	36 / 48	36 / 48
Max Travel Speed - loaded 36/48 Volt - mph	9.0 / 9.0	9.0 / 9.0	10.3 / 10.3	10.3 / 10.3	9.3 / 9.3
Max Travel Speed - empty 36/48 Volt - mph	10.6 / 10.6	10.6 / 10.3	10.6 / 10.6	10.6 / 10.6	10.6 / 10.6
Max Lift Speed - loaded 36/48 Volt - fpm	66.0 / 85.7	59.1 / 76.8	69.0 / 75.8	69.0 / 75.8	63.0 / 67.9
Max Lift Speed - empty 36/48 Volt - fpm	105.3 / 126.0	105.3 / 126.0	108.3 / 119.1	108.3 / 119.1	108.3 / 119.1
Min Outside Turning Radius - in	70.9	70.9	72.6	72.6	73.8
Overhead Guard Height - in	86.2	86.2	87.4	87.4	87.4

	BXC50R	BXC50LN ¹	BXC60N	BXC65N	BXC80N
Load Capacity - lbs	5000	5000	6000	6500	8000
Voltage	36 / 48	36 / 48	36 / 48	36 / 48	36 / 48
Max Travel Speed - loaded 36/48 Volt - mph	9.3 / 9.3	9.3 / 9.3	8.1 / 8.7	7.4 / 8.7	7.1 / 7.8
Max Travel Speed - empty 36/48 Volt - mph	10.6 / 10.6	10.6 / 10.6	9.3 / 9.3	9.3 / 9.3	9.0 / 9.0
Max Lift Speed - loaded 36/48 Volt - fpm	63.0 / 67.9	63.0 / 67.9	50.2 / 55.1	43.3 / 46.3	43.3 / 46.3
Max Lift Speed - empty 36/48 Volt - fpm	108.3 / 119.1	108.3 / 119.1	92.5 / 101.4	77.8 / 84.7	77.8 / 84.7
Min Outside Turning Radius - in	73.8	78.9	81.1	83.1	88.4
Overhead Guard Height - in	87.4	87.4	87.4	87.4	87.4

¹ Long Wheelbase Model

Reliability.

It's the defining trait of our company and our forklifts.



UniCarriers' roots extend back over 100 years, and over that time, strong, reliable performance has always been the hallmark of our organization, our people and our equipment.

Today, our unrivaled reliability continues to provide UniCarriers' customers with a competitive edge. And together, we move the merchandise that moves world commerce with greater efficiency, economy and reliability.

When it comes to providing forklifts that make a difference for our customers and theirs...



We Never Quit.

UNICARRIERS
[**FORKLIFT**]
UniCarriersAmericas.com



SB-BX 04-2020 Printed in U.S.A.

UniCarriers® is a registered trademark of UniCarriers Corporation. OPTIVIEW® is a registered trademark of UniCarriers Americas. UniCarriers Americas Corporation reserves the right to make product changes relating to colors, equipment, specifications or available options without notice. For more information, contact your UniCarriers representative.